

Linee Tecniche



mille modi per dire porta

Luoghi di utilizzo / Applications		EMPORIA	EMPORIA SOLIDA	LAMINIO - LAMINIO PLUS	RESINE	RESINE
	UFFICI, NEGOZI, CENTRI COMMERCIALI / OFFICES, SHOPS, SHOPPING CENTRES	■	■	■	■	■
	RISTORANTI, CINEMA, BAR / RESTAURANTS, CINEMAS, BARS	■	■	■	■	■
	PALESTRE / GYMNASIUMS	■	■	■	■	■
	CAPANNONI INDUSTRIALI / INDUSTRIAL SHEDS	■	■	■	■	■
	SCUOLE, ASILI / SCHOOLS, NURSERY SCHOOLS	■	■	■	■	■
	CENTRI ESTETICI, CENTRI BENESSERE / BEAUTY PARLOURS, WELLNESS CENTRES	■	■	■	■	■
	OSPEDALI, CLINICHE, STUDI DENTISTICI / HOSPITALS, CLINICS, DENTAL STUDIOS	■	■	■	■	■
	SAUNE, BAGNI TURCHI / SAUNAS, TURKISH BATHS	■	■	■	■	■
	PISCINE, CABINE DOCCIA / POOLS, SHOWER CABINS	■	■	■	■	■
Plus tecnici / Technical advantages						
	PULIZIA INDUSTRIALE / INDUSTRIAL CLEANING	■	■	■	■	■
	INSTALLAZIONE ALL'ESTERNO / OUTDOOR INSTALLATION	■	■	■	■	■
	RESISTENZA ALL'UMIDITÀ / RESISTANCE TO HUMIDITY	■	■	■	■	■
	SANIFICAZIONE E IGENIZZAZIONE / SANITISATION AND HYGIENISATION	■	■	■	■	■
	FASCIA DI PREZZO / PRICE RANGE	●●●●	●●●●	●●●●	●●●●	●●●●
	SU MISURA / CUSTOM-SIZED	■	■	■	■	■
		EN	ES	L-LP	R	R

Modelli / Models		EMPORIA	EMPORIA SOLIDA	LAMINIO - LAMINIO PLUS	RESINE	RESINE
	INSERTI ALLUMINIO / ALUMINIUM INSERTS	✓	✓			
	CON VETRO / WITH GLASS	✓	✓	✓	✓	
	INSONORIZZATA / SOUNDPROOF			✓		
	PIOMBO / LEAD	✓	✓			
Finiture telai e cornici / Frames and mouldings finishes						
	LACCATI / LAQUERED		✓			
	GOFFRATI / EMBOSSED		✓			
	LEGGI / WOODS		✓			
	SPECIALI / SPECIAL WOODS		✓			
	ALLUMINIO ANODIZZATO / ANODISED ALUMINIUM	✓	✓			
	ALLUMINIO COLORATO / COLOURED ALUMINIUM	✓	✓			
	PVC / PVC				✓	✓
		EN	ES	L-LP	R	R
Legenda / Key						
	MOLTO CONSIGLIATO / HIGHLY RECOMMENDED					
	ABBASTANZA CONSIGLIATO / FAIRLY RECOMMENDED					
	CONSIGLIATO / RECOMMENDED					

Accessori / Accessories		EMPORIA	EMPORIA SOLIDA	LAMINIO - LAMINIO PLUS	RESINE	RESINE
	GRIGLIE / GRIDS	✓	✓	✓	✓	✓
	CHIUDIORTA AEREO / AERIAL CLOSER	✓	✓	✓	✓	✓
	MANIGLIONI PER DISABILI / HANDLE FOR DISABLED PEOPLE	✓	✓	✓	✓	✓
	FASCE BATTICARRELO / DEFLECTOR BAND	✓	✓	✓	✓	✓
	MANIGLIA LIBERO-OCCUPATO / FREE-BUSY RESIN HANDLE	✓	✓	✓	✓	✓
	MANIGLIA IN RESINA / WHITE RESIN HANDLE	✓	✓	✓	✓	✓
	MANIGLIA IN ALLUMINIO ARGENTO / SILVER-PLATED ALUMINIUM HANDLE	✓	✓	✓	✓	✓
	MANIGLIA PREMI-APRI / PUSH-OPEN HANDLE	✓	✓	✓	✓	✓
		EN	ES	L-LP	R	R

Versioni / Versions		EMPORIA	EMPORIA SOLIDA	LAMINIO - LAMINIO PLUS	RESINE	RESINE
	BT - BATTENTE / HINGED	✓	✓	✓	✓	✓
	CS - CERNIERE A SCOMPARSA / CONCEALED HINGES			✓		
	FL - FUORI LUCE / OUT-OF-OPENING			✓	✓	✓
	FLB - FUORI LUCE CON BATTUTA / OUTSIDE OPENING WITH DOOR STOP			✓		
	FLBCS - FUORI LUCE CON BATTUTA CERNIERE A SCOMPARSA / OUTSIDE OPENING WITH DOOR STOP, CONCEALED HINGES			✓		
	PY - PORTONCINO / ENTRANCE	✓	✓	✓	✓	✓
	IL - INLINEA / INLINEA			✓		
	ILT - INLINEA A TIRARE / INLINEA A TIRARE			✓		
	TR - TRAPEZIO / TRAPEZIUM			✓		
	VV - VA E VIENI / DOUBLE-ACTING	✓	✓	✓	✓	✓
	L13 - LIBRO 1/3 - 2/3 / 1/3 - 2/3 FOLDING			✓		
		EN	ES	L-LP	R	R

Versioni / Versions		EMPORIA	EMPORIA SOLIDA	LAMINIO - LAMINIO PLUS	RESINE	RESINE
	L12 - LIBRO 1/2 - 1/2 / 1/2 - 1/2 FOLDING			✓		
	RT - ROTOTRASLANTE / ROTATING-SLIDING	✓		✓		
	LT - LIBRO TRASLANTE / ROTATING-SLIDING			✓		
	PV - PIVOT / PIVOT			✓		
	SS - SCORREVOLE SCOMPARSA / POCKET SLIDING	✓	✓	✓	✓	✓
	SE - SCORREVOLE ESTERNO / EXTERNAL SLIDING	✓	✓	✓	✓	✓
	SEB - SCORREVOLE ESTERNO CON BATTUTA / EXTERNAL SLIDING WITH DOOR STOP	✓	✓	✓	✓	✓
	SAR - SCORREVOLE ARMONICO / ARMONICO SLIDING			✓		
	SAP - SCORREVOLE APPLAUSO / APPLAUSO SLIDING			✓		
	SGL - SCORREVOLE GRAN LUCE / GRAN LUCE SLIDING			✓		
	SPR - SCORREVOLE PRATICO / PRATICO SLIDING			✓		
		EN	ES	L-LP	R	R



EMPORIA
porte con stipse in alluminio, ante tamburate in legno, laccate ed in laminato / double-panelled doors in wood, lacquers and laminates, with aluminium jambs

P. 12

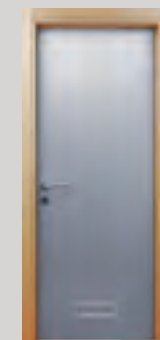

LAMINIO - LAMINIO PLUS
porte con stipse in legno, ante tamburate rivestite in supportato melaminico e in laminato plastico / double-panelled doors with wooden jambs, melamine backing and plastic laminate backing

P. 32



RESINE
porte con telaio in PVC, ante rivestite in supportato melaminico, laminato plastico o interamente in PVC (certificate classe 1 di reazione al fuoco) / PVC framed doors with melamine or plastic laminate backing, or built entirely

P. 48



Flessya nasce dall'incontro di un gruppo di professionisti con esperienza pluridecennale nel campo della produzione di porte per interni. La vasta gamma di proposte soddisfa tutte le esigenze, anche le più particolari o insolite; le porte Flessya si inseriscono in ambienti classici, rustici, moderni, grazie ad un sapiente equilibrio tra materiali, forme e finiture.

Flessya was founded by the meeting of a group of professionals with many years' experience in the field of interior door production. We can offer a vast range of proposals to meet all your requirements, even the most unusual or specific. The skilled balance of materials, designs and finishes make Flessya doors an equally perfect choice for classic, rustic and modern environments alike.



**Tecnologia,
funzionalità,
estetica**
/ Technology,
functionality,
aesthetics

Nuovi materiali, nuovi criteri costruttivi ci guidano nella realizzazione di porte tecniche che si inseriscono alla perfezione nei luoghi di lavoro, di svago, di pubblica utilità, nelle strutture ospedaliere.

Porte robuste, lavabili, ignifughe che, grazie a numerosi accorgimenti tecnici e ad una vasta gamma di colori e materiali sono in grado di arredare ogni stile/ambiente e di resistere all'usura e al tempo.

New materials, new design criteria guide us in the creation of technical doors that fit perfectly in the workplace, in leisure or common places, in hospitals.

Solid, washable, flame retardant doors that, thanks to technical expertise and a wide range of colours and materials, are able to decorate every style/environment and to resist wear and time.





Mettete alla prova la nostra flessibilità

/ Put our flexibility to the test

Siamo in grado di personalizzare i nostri modelli secondo le diverse esigenze dei clienti senza gravare sui costi di acquisto.

Lavoriamo ogni commessa "su misura" eliminando i supplementi di costo per dimensioni non standard all'interno di determinate categorie di misure.

We can customise our models according to the different needs of customers without increasing the cost of purchase. Every order is "custom-made", eliminating additional costs for non-standard sizes within certain categories of measures.



90X275 CM

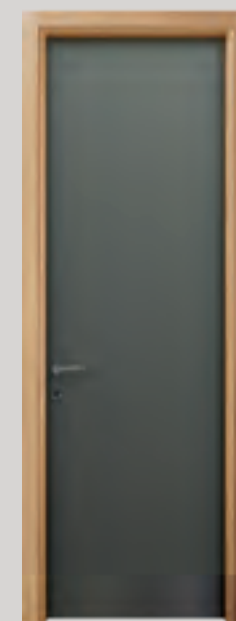

73X241 CM



80X210 CM



70X187 CM



Scoprite tutte le nostre proposte
/ Take a look at all our proposals

www.flessya.com

Alla creatività non si pongono limiti, per questo la nostra offerta è in continua evoluzione. Nel nostro sito www.flessya.com potete visionare le altre linee e le nuove proposte, risultato della ricerca e dell'innovazione tecnica ed estetica.

Creativity knows no limits, meaning that our offers are constantly evolving. Please visit our website www.flessya.com to see other lines and new proposals, the result of technical and aesthetic innovation and research.

- **NIDIO**
porte tamburate, in legno e laccate
double-panelled doors in wood and lacquers
- **TALÈA**
porte pantografate e laccate
pantographic lacquered doors
- **CLASSIKA**
porte laccate con pantografatura profonda
deep pantographic acquered doors
- **PLENIA**
porte in listellare impiallacciato
veneered strip doors
- **RASOMURO**
porte rasomuro da tinteggiare o finite
rasomuro doors to be painted or finished
- **KIKKA**
porte con vetro strutturale e bordo in legno massello
doors with structural glass and solid wood edge
- **VETRA**
porte con vetro monolitico
doors with monolithic glass
- **RECEPTIVA**
porte resistenti al fuoco e fonoassorbenti
fire resistant and sound absorbing doors
- **ANALOGICA**
porte rivestite in CPL
doors covered in CPL
- **S-NZIALE**
porte con telaio in alluminio e anta in legno o anta in vetro bordata in alluminio
doors with aluminium frame and wooden door or glass door with aluminium edge
- **EMPIRIA**
porte con stipite in alluminio, ante tamburate in legno, laccate ed in laminato
double-panelled doors in wood, lacquers and laminates, with aluminium jambs
- **LAMINIO**
porte con stipite in legno, ante tamburate rivestite in supportato melaminico
double-panelled doors with wooden jambs and melamine backing
- **LAMINIO PLUS**
porte con stipite in legno, ante tamburate rivestite in laminato plastico
double-panelled doors with wooden jambs and plastic laminate backing
- **RESINÆ**
porte con telaio in PVC, ante rivestite in supportato melaminico, laminato plastico o interamente in PVC (certificate classe 1 di reazione al fuoco)
PVC framed doors with melamine or plastic laminate backing, or built entirely from PVC (certified class 1 fire reaction)

Empiria

Caratteristiche tecniche / Technical features

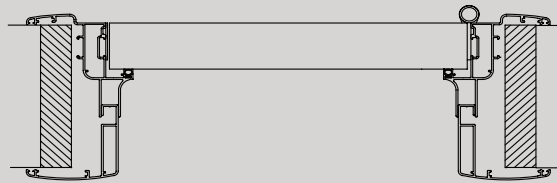

Anta tamburate sp. 43 mm
/ door hollow-core panels th. 43 mm

Ante: tamburate sp. 43 mm, intelaiate con massello di abete giuntato di sezione 38x38 mm, riempimento con nido d'ape microforato supercollato, placcato con pannelli di mdf sp. 3.2 mm impiallacciati con l'essenza richiesta, placcati con pannelli di supportato melaminico sp. 2.8 mm o con pannelli di mdf sp. 3.2 mm rivestiti con laminato plastico 9/10 mm finitura antigraffio (fin. 6), bordati con tranciato, con bordo melaminico finitura alluminio o con bordo laminato; anta interamente in laminato stratificato sp.14 mm

Telai: in alluminio anodizzato telescopici, guarnizione di battuta in gomma

Kit ferramenta cromata: serratura tipo patent, n. 2 cerniere a piastra in alluminio anodizzato



Cerniere a piastra in alluminio argento
Silver-plated aluminium hinges



Anta interamente in laminato stratificato sp. 14mm
/ door entirely in 14 mm thick stratified laminate

Doors: hollow-core panels th. 43 mm, framed with jointed solid fir, cross-section 38x38 mm, with micro-perforated honeycomb superglued filling, plated with mdf panels th. 3.2 mm veneered with the requested wood finish, plated with backed melamine panels th. 2.8 mm or with mdf panels th. 3.2 mm lined with 9/10 mm plastic laminate with scratch-resistant finish (fin. 6) with veneered edge, melamine edge with aluminium finish or laminate edge; door entirely in 14 mm thick stratified laminate

Frames: telescopic anodised aluminium frames, rubber closing seal

Chromed hardware kit: patent type lock, 2 anodised aluminium plate hinges



Angolo telaio, lato esterno
Frame angle, outer side

Finiture ante / Door leaf finish

Tamburate con bordo melaminico / Hollow-core with melamine edge

SUPPORTATI / SUPPORTED

- 400 bianco / white 1630
- 401 avorio / ivory 0624
- 402 grigio / grey 0074
- 403 giallo / yellow 0212
- 404 azzurro / light blue 0717

LAMINATI / LAMINATED

- 500 bianco / white 406
- 501 avorio / ivory 414
- 502 grigio / grey 475
- 599 colore a scelta / colour of choice

Laminato stratificato sp. 14 mm / th. 14 mm stratified laminate

LAMINATI / LAMINATED

- 500S bianco / white MKB0101
- 501S avorio / ivory MKC0171
- 502S grigio chiaro / light grey MK4751
- 503S grigio antracite / anthracite grey MKG0591
- 504S verde / green MKC0491
- 505S azzurro / blue MKC0181

Tamburate bordate PVC / Hollow-core with PVC edge

SUPPORTATI / SUPPORTED

- 400 bianco / white 1630
- 401 avorio / ivory 0624
- 402 grigio / grey 0074
- 403 giallo / yellow 0212
- 404 azzurro / light blue 0717

LAMINATI / LAMINATED

- 500 bianco / white 406
- 501 avorio / ivory 414
- 502 grigio / grey 475
- 599 colore a scelta / colour of choice

PVC (doghe) certificate classe 1

/ PVC (slats) class 1 fire reaction certified

- B bianco / white
- A avorio / ivory
- G grigio chiaro / light grey
- X altri colori pvc / other pvc colour

LAMINATI SU PVC certificate classe 1

/ LAMINATED ON PVC class 1 fire reaction certified

- 500P bianco / white
- 501P avorio / ivory
- 502P grigio / grey
- 599P colore a scelta / colour of choice





EN00
ANTA IN LAMINATO ABET MET DECOR 746
TELAIO ALLUMINIO ARGENTO
/ ABET MET DECOR 746 LAMINATED DOOR
SILVER-PLATED ALUMINIUM FRAME



EN00
ANTA IN LAMINATO ABET 421
TELAIO ALLUMINIO STAROX STRO51 ROSSO
/ ABET 421 LAMINATED DOOR
RED STAROX STRO51 ALUMINIUM FRAME

EN00
ANTA ABET 879 GRIGIO
TELAIO ALLUMINIO ARGENTO
/ ABET 879 GREY DOOR
SILVER-PLATED ALUMINIUM FRAME





ENO1
ANTA ABET 879 GRIGIO
TELAIO ALLUMINIO ARGENTO
/ ABET 879 GREY DOOR
SILVER-PLATED ALUMINIUM FRAME





ES00
ANTA VERDE MKC0491
TELAIO ALLUMINIO BIANCO RAL 9016
/ MKC0491 GREEN DOOR
RAL 9016 WHITE ALUMINIUM FRAME





ENOO
ANTA ABET 406 BIANCO
TELAIO E BORDO ANTA ALLUMINIO ARGENTO
/ ABET 406 WHITE DOOR
SILVER-PLATED ALUMINIUM FRAME AND DOOR EDGE





ER00
ANTA E BORDO ANTA PVC A DOGHE
GRIGIO CHIARO
TELAIO ALLUMINIO GRIGIO RAL 7016
/ LIGHT GREY DOOR AND DOOR EDGE
WITH SLATTED PVC DOORS
RAL 7016 GREY ALUMINIUM FRAME

Empiria Modelli / Models

Modello base / Basic model



EN00
ER00 (ANTA PVC
/ PVC LEAF)

ES00 (ANTA 14 MM
/ 14 MM LEAF)

Modelli con vetro / Models with glass



EN50
ER50 (ANTA PVC
/ PVC LEAF)

EN50S
ER50S (ANTA PVC
/ PVC LEAF)

EN53
ER53 (ANTA PVC
/ PVC LEAF)

EN69
ER69 (ANTA PVC
/ PVC LEAF)

Modelli inserti alluminio / Models inlay work in aluminium



EN01D

EN01

EN02

EN03

EN04

Modelli inserti stondati / Models inlay work rounded



ENI00

ENI01

ENI02

ENI03

ENI04

Empiria Versioni / Versions

BT BATTENTE
/ HINGED

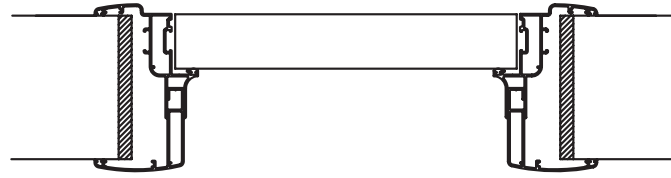

PY PORTONCINO
/ ENTRANCE

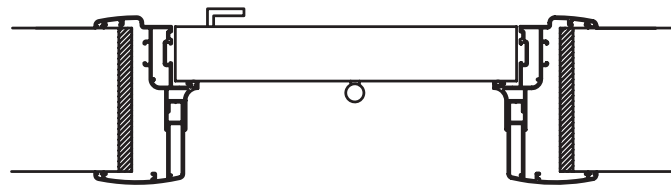

VV VA E VIENI
/ DOUBLE-ACTING

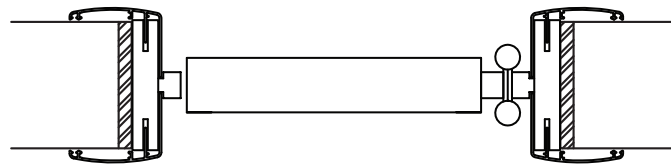

RT ROTOTRASLANTE
/ ROTATING-SLIDING

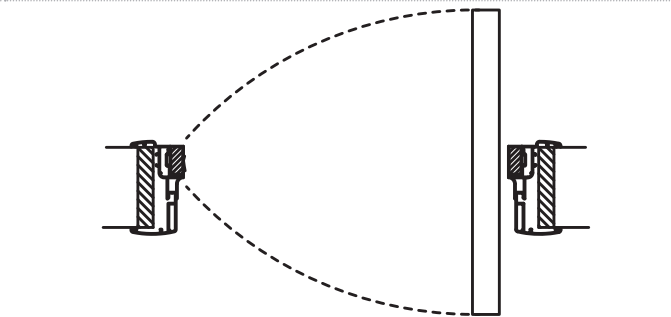

Empiria Versioni / Versions

SS SCORREVOLE SCOMPARSA
/ POCKET SLIDING

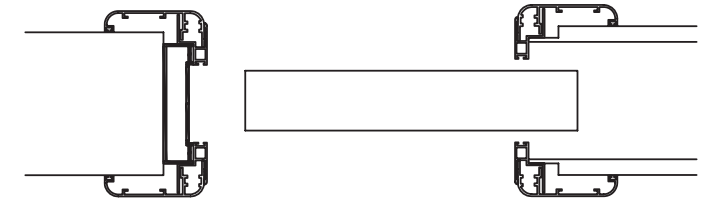

SE SCORREVOLE ESTERNO
/ EXTERNAL SLIDING

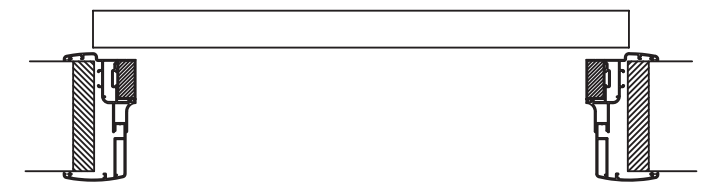

SEB SCORREVOLE ESTERNO
CON BATTUTA
/ EXTERNAL SLIDING WITH DOOR STOP

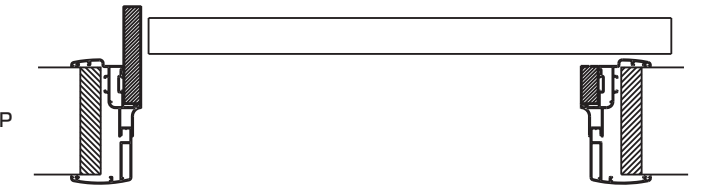

Empiria Telai / Frames

Telaio in alluminio telescopico con vari tipi di imbotti o prolunghe / Telescopic aluminium frame with various types of padding or extensions

TELAIO STANDARD
/ STANDARD FRAME



spessore muro 10,5 / 13,5 cm
/ wall thickness 10.5 / 13.5 cm

TELAIO CON IMBOTTE MAGGIORATO
/ FRAME WITH IMPROVED PADDINGS



spessore muro 14,0 / 16,5 cm
/ wall thickness 14.0 / 16.5 cm

TELAIO CON IMBOTTE MAGGIORATO
/ FRAME WITH IMPROVED PADDINGS



spessore muro 17,0 / 19,5 cm
/ wall thickness 17.0 / 19.5 cm

Telai Empiria con prolungamento / Empiria frames with extensions

Telaio con aggiunta di 1 o più prolungamenti / Frame with one or more extra extensions

TELAIO CON 1 PROLUNGAMENTO
/ FRAME WITH 1 EXTENSION



spessore muro 19,0 / 21,5 cm
/ wall thickness 19.0 / 21.5 cm

TELAIO CON 1 PROLUNGAMENTO
E IMBOTTE MAGGIORATO
/ FRAME WITH 1 EXTENSION AND
IMPROVED PADDINGS



spessore muro 22,0 / 24,5 cm
/ wall thickness 22.0 / 24.5 cm

TELAIO CON 1 PROLUNGAMENTO
E IMBOTTE MAGGIORATO
/ FRAME WITH 1 EXTENSION AND
IMPROVED PADDINGS



spessore muro 25,0 / 27,5 cm
/ wall thickness 25.0 / 27.5 cm

Per spessori muro maggiori è possibile aggiungere ulteriori prolungamenti
/ Further extensions can be added for even thicker walls

Empiria Colori - finiture / Colours - finishes

Supportati / Backed panels

Colori ante / Doors colours



BIANCO
/ WHITE
1630

AVORIO
/ IVORY
0624

GIALLO
/ YELLOW
0212

AZZURRO
/ BLUE
0717

GRIGIO
/ GREY
0074

Laminati / Laminates

Colori ante / Doors colours



BIANCO
/ WHITE
ABET 406

AVORIO
/ IVORY
ABET 414

GRIGIO
/ GREY
ABET 475

TUTTI ABET
/ ALL ABET

Laminati sp. 14 mm / th. 14 mm laminates

Colori ante / Doors colours



BIANCO
/ WHITE
MKB0101

AVORIO
/ IVORY
MKC0171

GRIGIO CHIARO
/ LIGHT GREY
MK4751

VERDE
/ GREEN
MKC0491

AZZURRO
/ BLUE
MKC0181

GRIGIO ANTRACITE
/ ANTHRACITE GREY
MKG0591

Tipi di alluminio / Types of aluminium

Colori telai / Frames colours



ARGENTO
FINITURA
STANDARD
/ SILVER
STANDARD
FINISH

BIANCO
/ BIANCO
RAL 9016

NERO
/ BLACK
RAL 9005

GRIGIO
ANTRACITE
/ ANTHRACITE
GREY
RAL 7016

TUTTI RAL
/ ALL RAL

Laminio

Caratteristiche tecniche / Technical features

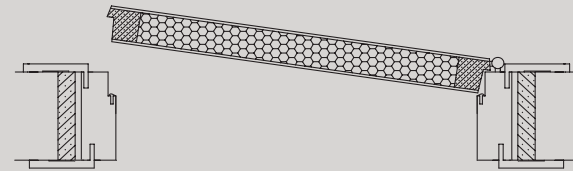

Ante: tamburate sp. 44 mm, intelaiate con massello di legno di abete giuntato di sezione 38x38 mm, riempimento con nido d'ape microforato supercollato, placcato con pannelli di supportato melaminico sp.2.8 mm, bordati con rivestimento melaminico

Telai: in listellare impiallacciato sezione 40 mm, guarnizione di battuta in gomma, cornici telescopiche in multistrato impiallacciato

Finitura: fondo e mano di finitura con vernici poliuretatiche opache ecocompatibili o acriliche

Kit ferramenta nichelata: serratura tipo patent, n. 3 cerniere in acciaio diametro 14 mm

Doors: hollow-core panels Th. 44 mm, framed with jointed solid fir cross section 38x38 mm, with micro-perforated honeycomb superglued filling, plated with backed melamine panels Th. 2.8 mm, with melamine faced edging

Frames: veneered blockboard frames 40 mm cross-section, rubber closing seal, telescopic multi-ply veneered mouldings

Finish: base and finishing coat with eco-friendly matt polyurethane or acrylic paint

Nickel-plated hardware kit: patent type lock, 3 steel hinges with 14 mm diameter

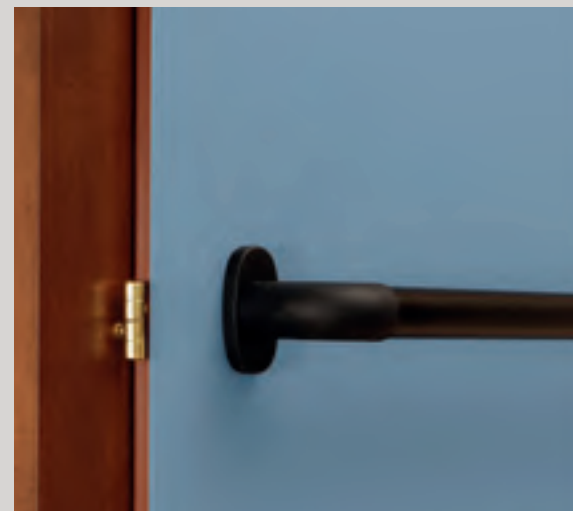

Bordo anta della stessa finitura del telaio
/ Door edge with the same finish as the frame

Laminio Plus

Caratteristiche tecniche / Technical features

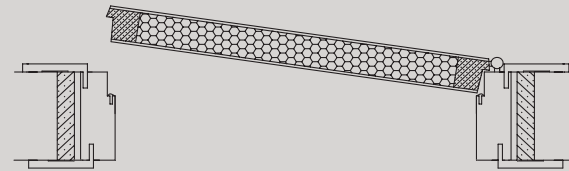

Ante: tamburate sp. 46 mm, intelaiate con massello di abete giuntato di sezione 38x38 mm, riempimento con nido d'ape microforato supercollato, placcato con pannelli di mdf sp. 3.2 mm rivestiti in laminato plastico sp. 9/10 mm finitura antigraffio (fin. 6), bordati con rivestimento melaminico

Telai: in listellare impiallacciato sezione 40 mm, guarnizione di battuta in gomma, cornici telescopiche in multistrato impiallacciato

Finitura: fondo e mano di finitura con vernici poliuretatiche opache ecocompatibili o acriliche

Kit ferramenta nichelata: serratura tipo patent, n. 3 cerniere in acciaio diametro 14 mm

Doors: hollow-core panels Th. 46 mm, framed with jointed solid fir, cross-section 38x38 mm, with micro-perforated honeycomb superglued filling, plated with MDF panels Th. 3.2 mm lined with plastic laminate Th. 9/10 mm scratch-resistant finish (fin. 6), melamine edging

Frames: veneered blockboard frames 40 mm cross-section, rubber closing seal, telescopic multi-ply veneered mouldings

Finish: base and finishing coat with eco-friendly matt polyurethane or acrylic paint

Nickel-plated hardware kit: patent type lock, 3 steel hinges with 14 mm diameter



Telaio e cornici laccati, anta in laminato
/ Frame and lacquered mouldings, laminated door

Finiture telai / Frame finish

LACCATI / LACQUERED

- | | |
|---|--|
| 0 | laccato bianco / white lacquered
RAL 9016 |
| 1 | laccato avorio / ivory lacquered
RAL 1013 |
| 2 | laccato bianco crema / cream
white lacquered RAL 9001 |
| 3 | laccato base / basic lacquered |
| 4 | laccato extra / extra lacquered |
| 5 | laccato bianco puro / pure white
lacquered RAL 9010 |
| 6 | laccato colori idea / idea colours
lacquered |
| 7 | laccato corten / corten lacquered |
| 9 | laccato nero / black lacquered
RAL 9005 |

GOFFRATI / EMBOSSED

- | | |
|----|--|
| 10 | goffrato standard-idea /
standard-idea embossed |
| 11 | goffrato base-extra / base-extra
embossed |

LEGNI / WOOD

- | | |
|-----|--|
| 100 | tanganika / tanganika |
| 101 | tanganika cuoio / leather tanganika |
| 102 | tanganika ciliegio / cherry tanganika |
| 103 | tanganika tabacco / tobacco tanganika |
| 120 | rovere / oak |
| 121 | rovere tabacco / tobacco oak |
| 122 | rovere caffè / coffee oak |
| 123 | rovere sbiancato / bleached oak |
| 126 | rovere grigio / grey oak |
| 127 | rovere cenere / oak ash |
| 140 | noce nazionale bicolore /
two-coloured walnut |
| 150 | ciliegio / cherry |

SPECIALI (previa richiesta disponibilità) / SPECIAL upon request availability)

- | | |
|-----|-----------------------------------|
| 110 | mogano / mahogany |
| 170 | noce biondo / blond walnut |
| 181 | frassino antico / antique ash |
| 183 | frassino sbiancato / bleached ash |
| 200 | acero / maple |
| 210 | teak / teak |
| 220 | zebrano / zebrano |

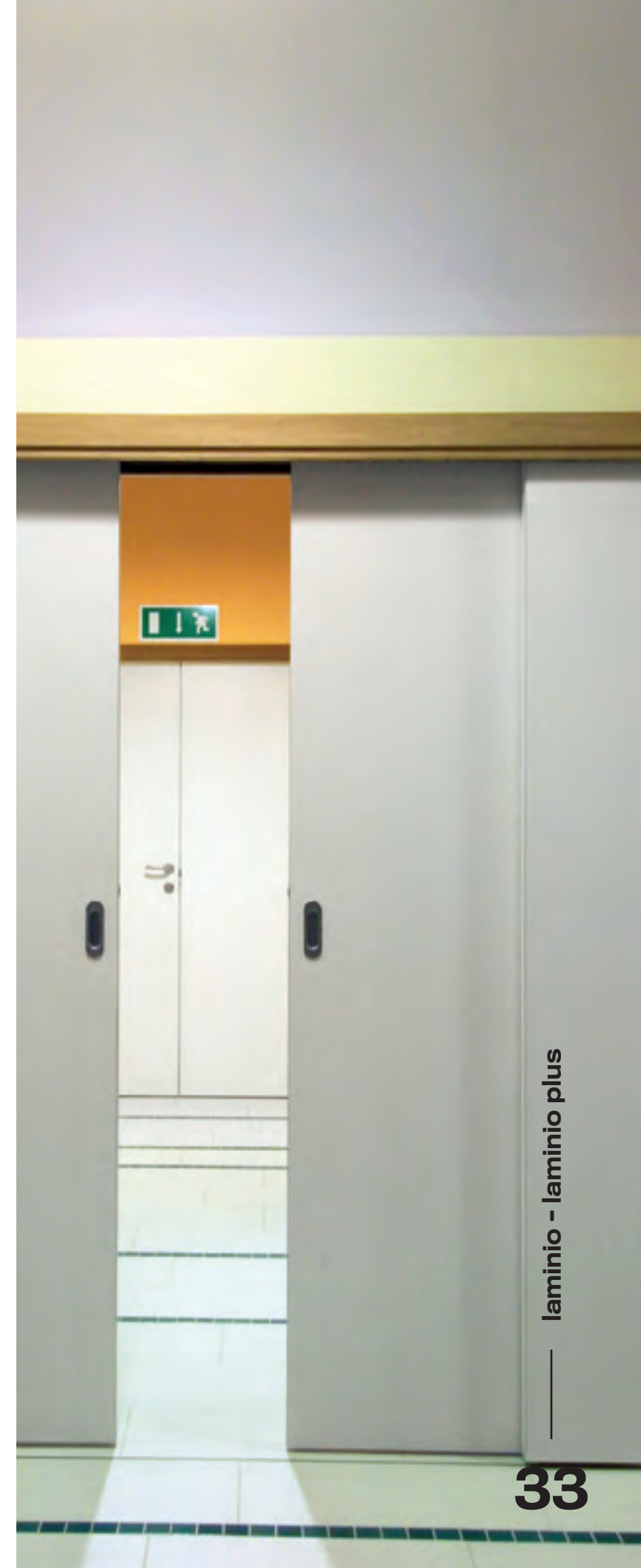



LP00
ANTA LAMINATO 879 LAVAGNA
TELAIO RADIUS - CORNICE RECTA
LACCATO RAL 7035
/ 879 BLACKBOARD LAMINATED DOOR
RADIUS FRAME - RECTA MOULDING RAL
7035 LACQUERED



LP00
ANTA LAMINATO ABET 877
TELAIO LINEO - CORNICE RECTA TANGANIK
/ ABET 877 LAMINATED DOOR
LINEO FRAME - TANGANIK RECTA MOULDING



L00
ANTA SUPPORTATO AVORIO
TELAIO LINEO
CORNICE RECTA TANGANIK
/ IVORY BACKED PANEL DOOR
LINEO FRAME
TANGANYIKA RECTA MOULDING



LP00
ANTA LAMINATO 877 MILLERIGHE
TELAIO LINEO
CORNICE PLANA LACCATO RAL 9006
/ 877 MULTI-LINE LAMINATED DOOR
LINEO FRAME
PLANA MOULDING RAL 9006 LACQUERED

LP53
A DISEGNO / DESIGN
ANTA ABET 475
TELAIO LINEO LACCATO RAL 7016
CORNICE RECTA
/ ABET 475 DOOR
RAL 7016 LACQUERED LINEO FRAME
RECTA MOULDING





Rototraslante / Rototranslating

Porta rototraslante con anta decentrata sul telaio

Pivot -and-sliding door with door leaf decentred on frame

- **Ingombro di apertura inferiore del 50%** rispetto ad una porta a battente
- **Doppio senso di apertura**, sia a spingere che a tirare
- Utile per risolvere il problema di **porte attigue**
- Ideale per **accessibilità ambienti** a persone disabili
- **Small apertures less than 50%** compared to a swinging door
- **Two-way opening**, both pushing and pulling
- Useful in order to solve the problem of **adjacent doors**
- Ideal for the **accessibility** of disabled people

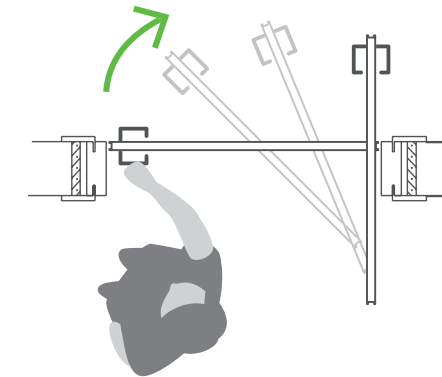
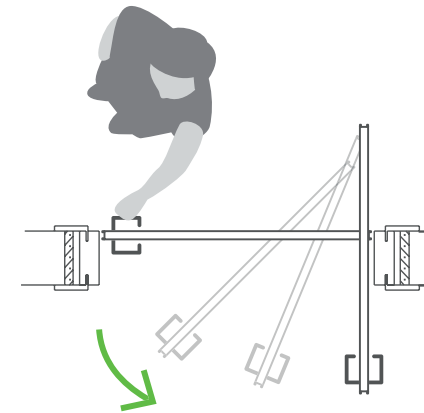

Laminio - Laminio Plus Modelli / Models

Modelli inserti alluminio / Models inlay work in aluminium



L00 - LP00

L01 - LP01

L02 - LP02

L03 - LP03

L04 - LP04

Modelli inserti stondati / Models inlay work rounded



LI00 - LPI00

LI01 - LPI01

LI02 - LPI02

LI03 - LPI03

LI04 - LPI04

Modelli con vetro / Models with glass



L50 - LP50

L50S - LP50S

L53 - LP53

L69 - LP69

Modelli speciali / Special models



LINSO - LPINSO
INSONORIZZATA
/ SOUNDPROOF

LPB - LPPB
PIOMBO
/ LEAD

Laminio - Laminio Plus Versioni / Versions

BT	BATTENTE / HINGED	
CS	CERNIERE A SCOMPARSA / CONCEALED HINGES	
FL	FUORI LUCE / OUT-OF-OPENING	
FLB	FUORI LUCE CON BATTUTA / OUTSIDE OPENING WITH DOOR STOP	
FLBCS	FUORI LUCE CON BATTUTA CERNIERE A SCOMPARSA / OUTSIDE OPENING WITH DOOR STOP, CONCEALED HINGES	
PY	PORTONCINO / ENTRANCE	
IL	INLINEA / INLINEA	
ILT	INLINEA A TIRARE / INLINEA A TIRARE	
TR	TRAPEZIO / TRAPEZIUM	
VV	VA E VIENI / DOUBLE-ACTING	
RT	ROTOTRASLANTE / ROTATING-SLIDING	
PV	PIVOT / PIVOT	

L13	LIBRO 1/3 - 2/3 / 1/3 - 2/3 FOLDING	
L12	LIBRO 1/2 - 1/2 / 1/2 - 1/2 FOLDING	
LT	LIBRO TRASLANTE / ROTATING-SLIDING	
SS	SCORREVOLE SCOMPARSA / POCKET SLIDING	
SE	SCORREVOLE ESTERNO / EXTERNAL SLIDING	
SEB	SCORREVOLE ESTERNO CON BATTUTA / EXTERNAL SLIDING WITH DOOR STOP	
SAR	SCORREVOLE ARMONICO / ARMONICO SLIDING	
SAP	SCORREVOLE APPLAUSO / APPLAUSO SLIDING	
SGL	SCORREVOLE GRAN LUCE / GRAN LUCE SLIDING	
SPR	SCORREVOLE PRATICO / PRATICO SLIDING	

Laminio - Laminio Plus Telai e cornici

/ Frames and architraves

Lineo

Telaio squadrato con doppia fresata per inserimento cornici telescopiche e guarnizione di battuta.
/ Square frame with double milling for the introduction of telescopic architraves and door stop gasket.

LINEO + RECTA
70X30 MM

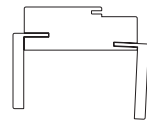

LINEO + PLANA
85X12 MM

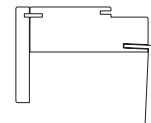

LINEO + CURVA
80X40 MM

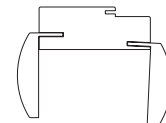

LINEO + SAGOMA
75X40 MM

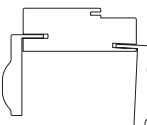

LINEO + AMPIA
80X30 MM

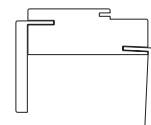

LINEO + BAROCCA
90X38 MM

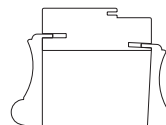

LINEO + UNGHIATA
90X20 MM

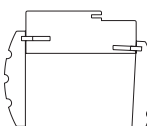

LINEO + MINI
50X30 MM

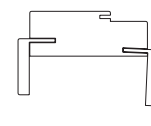

LINEO + DESIGN
60X12 MM

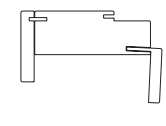

cornici ad incastro senza aletta
telescopica / fitted frame without
telescopic fin

da posare senza controtelaio in
legno / to be installed without wooden
counter-frame

da posare senza controtelaio in
legno / to be installed without wooden
counter-frame

Radius

Telaio arrotondato raggio 10 mm con doppia fresata per inserimento cornici telescopiche.
/ Ray 10 mm frame with double milling for the introduction of telescopic architraves and door stop gasket.

RADIUS + RECTA
70X30 MM

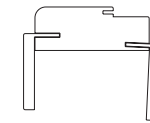

RADIUS + CURVA
80X40 MM

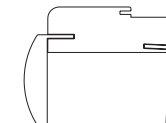

RADIUS + SAGOMA
75X40 MM

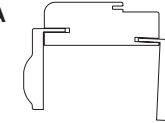

Sinuo

Telaio arrotondato raggio 50 mm con doppia fresata per inserimento cornici telescopiche e guarnizione di battuta.
/ Ray 50 mm frame with double milling for the introduction of telescopic architraves and door stop gasket.

SINUO + RECTA
70X30 MM

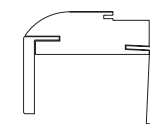

SINUO + CURVA
80X40 MM

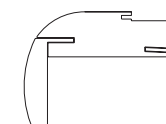

SINUO + SAGOMA
75X40 MM

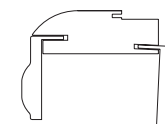

Laminio - Laminio Plus Colori ante / Door colours

Supportati / Backed panels



BIANCO
/ WHITE
1630

AVORIO
/ IVORY
0624

GIALLO
/ YELLOW
0212

AZZURRO
/ BLUE
0717

GRIGIO
/ GREY
0074

Laminati / Laminates

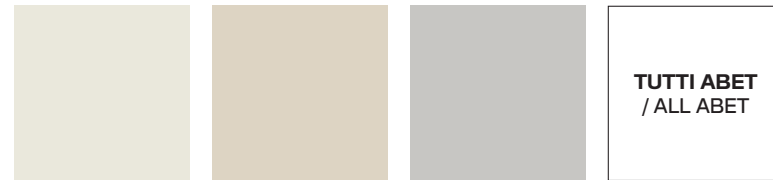

BIANCO
/ WHITE
ABET 406

AVORIO
/ IVORY
ABET 414

GRIGIO
/ GREY
ABET 475

TUTTI ABET
/ ALL ABET

Laminio - Laminio Plus Colori telai / Frame colours

Laccati / Lacquered

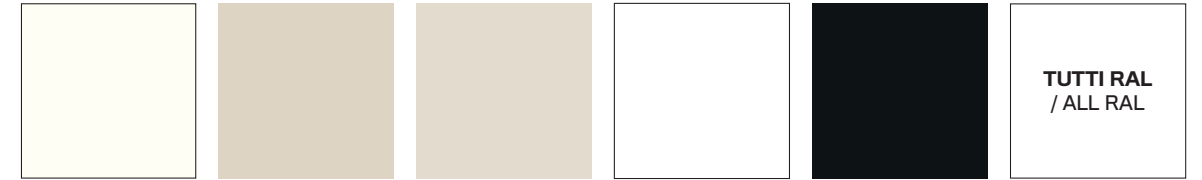

BIANCO
/ WHITE
RAL 9016

AVORIO
/ IVORY
RAL 1013

BIANCO CREMA
/ CREAM WHITE
RAL 9001

BIANCO PURO
/ PURE WHITE
RAL 9010

NERO
/ BLACK
RAL 9005

TUTTI RAL
/ ALL RAL

Legni / Woods



TANGANIKA
/ TANGANIKA

TANGANIKA
CUOIO
/ LEATHER
TANGANIKA

TANGANIKA
CILIEGIO
/ CHERRY
TANGANIKA

TANGANIKA
TABACCO
/ TOBACCO
TANGANIKA

ROVERE
/ OAK

ROVERE
TABACCO
/ OAK TOBACCO

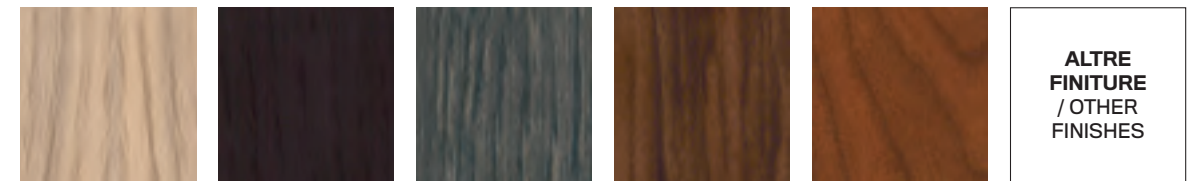

ROVERE
SBIANCATO
/ OAK BLEACHED

ROVERE CAFFÈ
/ OAK COFFEE

ROVERE GRIGIO
/ OAK GREY

NOCE
NAZIONALE
BICOLORE
/ TWO-TONE
WALNUT

CILIEGIO
/ CHERRY

ALTRE
FINITURE
/ OTHER
FINISHES

1,

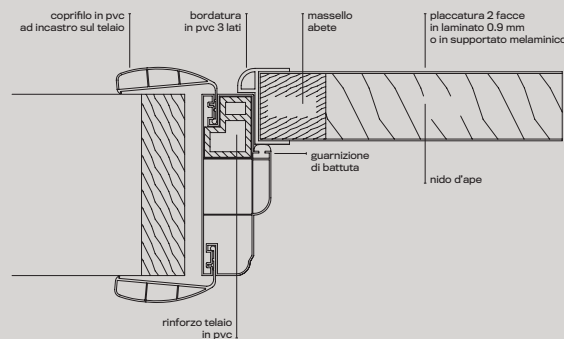

Ante:

- tamburata in legno sp. 40 mm, intelaiatura con massello di abete giuntato di sezione 34x38 mm, riempimento con nido d'ape microforato supercollato, placcato con pannelli di supportato melaminico sp. 2.8 mm o con pannelli di mdf sp. 3.2 mm rivestiti con laminato plastico 9/10 mm, bordati con profilo di battuta in PVC su 3 lati
- interamente in PVC sp. 40 mm, composta da profili pluricellulari estrusi in PVC rigido di sezione 125x40 mm, rinforzata lateralmente con profili estrusi in PVC rigenerato, bordate con profilo di battuta in PVC su 4 lati (certificata CLASSE 1)
- interamente in PVC e rivestita in laminato sp. 40 mm, composta da profili pluricellulari estrusi in PVC rigido di sezione 125x37 mm, rinforzata lateralmente con profili estrusi in PVC rigenerato e rivestita con laminato plastico 9/10 mm, bordati con profilo di battuta in PVC su 4 lati (certificata CLASSE 1)

Telai: realizzato con profilo pluricellulare estruso in PVC, rinforzato sul lato cerniere con profilo estruso in PVC rigenerato, di forma arrotondata, completo di guarnizione di battuta

Cornici: telescopiche in PVC estruso

Kit ferramenta cromata: serratura tipo patent, n. 3 cerniere in acciaio rivestite in resina diametro 14 mm.

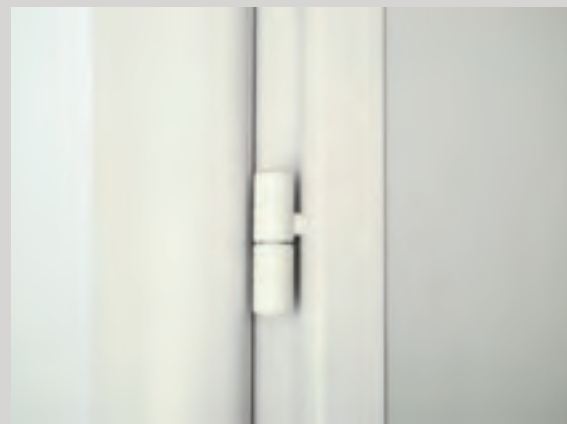

Cerniere resinæ antiumidità
/ Anti-humidity hinges treated with resin

2. 3. **Certificate classe 1 reazione al fuoco / Class 1 fire reaction certified**

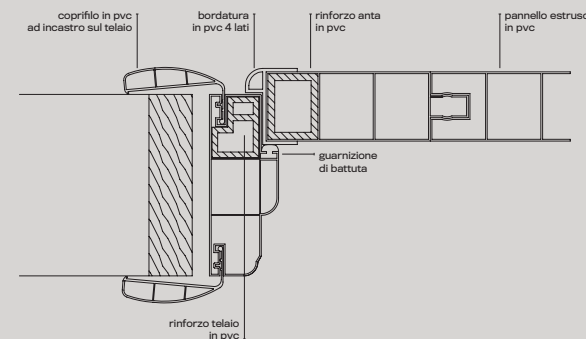

Doors:

- wood hollow-core Th. 40 mm, jointed fir frame cross-section 34x38 mm, micro-perforated honeycomb superglued filling, plated with backed melamine panels Th. 2.8 mm or with MDF panels Th. 3.2 mm lined with 9/10 mm plastic laminate, PVC stop profile edge on 3 sides
- entirely made of 40 mm PVC, composed of rigid PVC extruded multi-cell profiles, cross-section 125x40 mm, laterally reinforced with regenerated PVC extruded profiles, PVC stop profile edge on 4 sides (CLASS 1 certified)
- entirely made of PVC lined with 40 mm thick laminate, composed of rigid PVC multi-cell extruded profiles, cross-section 125x37 mm, laterally reinforced with regenerated PVC extruded profiles and lined with 9/10 mm plastic laminate, PVC stop profile edge on 4 sides (CLASS 1 certified)

Frames: composed of extruded PVC multi-cell profile, reinforced on the hinge side with a rounded regenerated PVC extruded profile, inclusive of closing seal

Mouldings: telescopic, made of extruded PVC

Chromed hardware kit: patent type lock, 3 steel hinges lined with resin, 14 mm diameter.



Coprigiunta per assemblaggio cornici telescopiche
/ Butt-straps for assembling telescopic mouldings

Finiture ante Door leaf finish

SUPPORTATI / SUPPORTED

- 400 bianco / white 1630
- 401 avorio / ivory 0624
- 402 grigio / grey 0074
- 403 giallo / yellow 0212
- 404 azzurro / light blue 0717

LAMINATI / LAMINATED

- 500 bianco / white 406
- 501 avorio / ivory 414
- 502 grigio / grey 475
- 599 colore a scelta / colour of choice

PVC (doghe) certificate classe 1 / PVC (slats) class 1 fire reaction certified

- B bianco / white
- A avorio / ivory
- G grigio chiaro / light grey
- X altri colori pvc / other pvc colour

LAMINATI SU PVC certificate classe 1 / LAMINATED ON PVC class 1 fire reaction certified

- 500P bianco / white
- 501P avorio / ivory
- 502P grigio / grey
- 599P colore a scelta / colour of choice





R00
ANTA SUPPORTATO BIANCO
TELAIO CORNICI E BORDO ANTA NERI
/ WHITE BACKED PANEL DOOR
BLACK MOULDING FRAME AND DOOR
BORDER



R00
ANTA IN LAMINATO ABET 421 NERO
TELAIO CORNICI E BORDO ANTA BIANCHI
/ BLACK ABET 421 LAMINATED DOOR
WHITE MOULDING FRAME AND DOOR BORDER



R00
ANTA IN LAMINATO SU PVC ABET 870 GRIGIO
TELAIO CORNICI E BORDO ANTA BIANCHI
/ GREY ABET 870 PVC LAMINATED DOOR
WHITE MOULDING FRAME AND DOOR
BORDER





R00
ANTA SUPPORTATO GIALLO
TELAIO CORNICI E BORDO ANTA BIANCHI
/ YELLOW BACKED PANEL DOOR
WHITE MOULDING FRAME AND DOOR
BORDER



R00
ANTA IN LAMINATO ABET 1820
TELAIO CORNICI E BORDO ANTA GIALLO
/ ABET 1820 LAMINATED DOOR
YELLOW MOULDING FRAME AND DOOR BORDER



R00
ANTA PVC A DOGHE BLU
TELAIO BLU - CORNICI E BORDO ANTA NERI
/ BLUE SLATTED PVC DOOR
BLUE FRAME - BLACK MOULDING AND
DOOR BORDER



R00
ANTA SUPPORTATO GRIGIO
TELAIO CORNICI E BORDO ANTA GRIGIO CHIARO
/ GREY BACKED PANEL DOOR
LIGHT GREY MOULDING FRAME AND
DOOR BORDER

Resinæ Modelli / Models

Modelli ante in laminato o supportato / Models with laminate or backed panel doors



Modelli ante in laminato su PVC / Models with laminate doors on PVC



Modelli ante in PVC a doghe / Models with slatted PVC doors



Resinæ Versioni / Versions

BT BATTENTE
/ HINGED

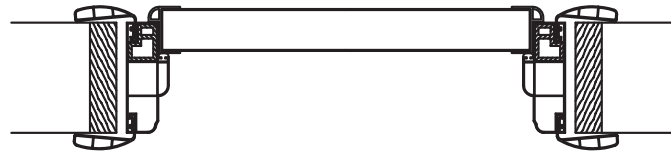

FL FUORI LUCE
/ OUT-OF-OPENING

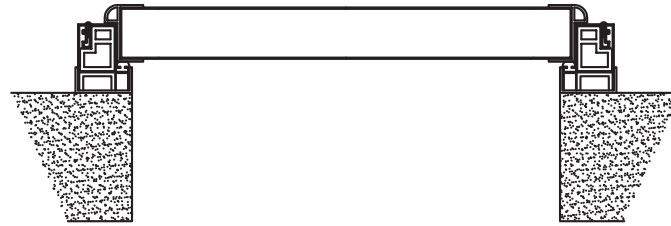

PY PORTONCINO
/ ENTRANCE

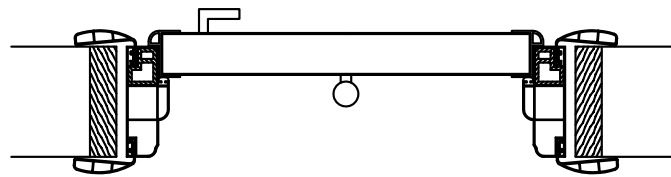

VV VA E VIENI
/ DOUBLE-ACTING

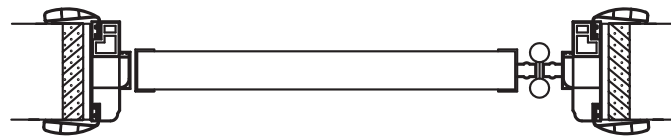

SS SCORREVOLE SCOMPARSA
/ POCKET SLIDING

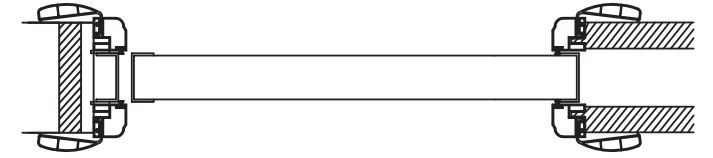

SE SCORREVOLE ESTERNO
/ EXTERNAL SLIDING

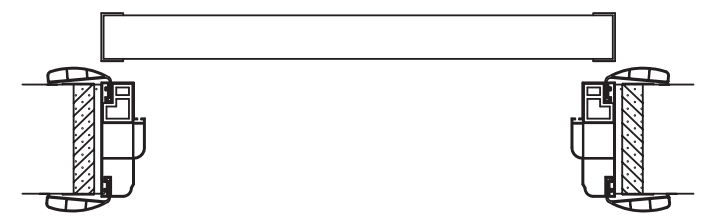

SEB SCORREVOLE ESTERNO
CON BATTUTA
/ EXTERNAL SLIDING
WITH DOOR STOP

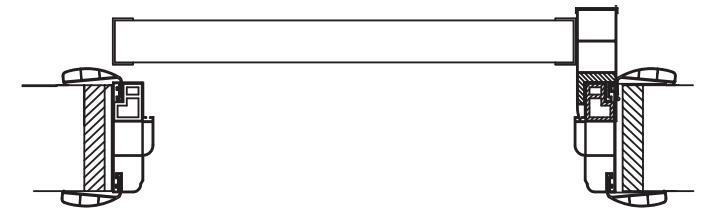

Resinæ Telai / Frames

Telaio con prolungamenti complanari / Telaio con prolungamenti complanari

TELAIO STANDARD
/ STANDARD FRAME



spessore muro 9,0 / 12,5 cm
/ wall thickness 9.0 / 12.5 cm

TELAIO CON PROLUNGAMENTO
DA 3,5 CM
/ FRAME WITH AN EXTENSION OF
3.5 CM



spessore muro 12,5 / 16,0 cm
/ wall thickness 12.5 / 16.0 cm

TELAIO CON PROLUNGAMENTO
DA 7,0 CM
/ FRAME WITH AN EXTENSION OF
7.0 CM



spessore muro 16,0 / 20,0 cm
/ wall thickness 16.0 / 20.0 cm



Resinæ Colori ante

/ Door colours

Supportati / Backed panels



BIANCO
/ WHITE
1630

AVORIO
/ IVORY
0624

GIALLO
/ YELLOW
0212

AZZURRO
/ BLUE
0717

GRIGIO
/ GREY
0074

Laminati / Laminates



BIANCO
/ WHITE
ABET 406

AVORIO
/ IVORY
ABET 414

GRIGIO
/ GREY
ABET 475

TUTTI ABET
/ ALL ABET

PVC / PVC

Colori anta, bordo anta, telai e cornici / Doors, door edges, frame and moulding colours



BIANCO
/ WHITE

AVORIO
/ IVORY

NERO
/ BLACK

GRIGIO CHIARO
/ LIGHT GREY

GRIGIO SCURO
/ DARK GREY

GRIGIO PERLA
/ PEARL GREY



ROSSO
/ RED

GIALLO
/ YELLOW

VERDE
/ GREEN

BLU
/ BLUE

MARRONE
/ BROWN

BEIGE
/ BEIGE

Accessori / Accessories

Maniglie / Handles

RESINA BIANCA
/ WHITE RESIN



RESINA LIBERO-OCCUPATO
/ FREE-BUSY RESIN

interno / inside



esterno / outside



HCS



ALLUMINIO ARGENTO
/ SILVER-PLATED ALUMINIUM

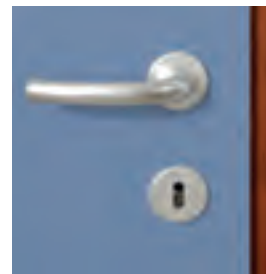

ALLUMINIO ARGENTO LIBERO-OCCUPATO
/ FREE-BUSY SILVER-PLATED ALUMINIUM

interno / inside

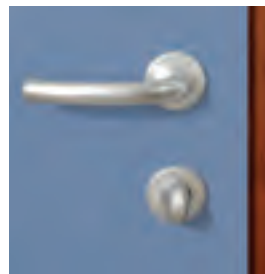

esterno / outside

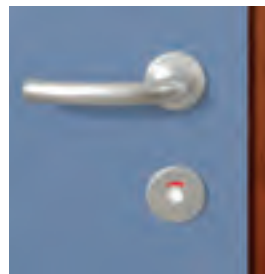

ALLUMINIO ANTINFORTUNISTICA
/ ACCIDENT PREVENTION ALUMINIUM

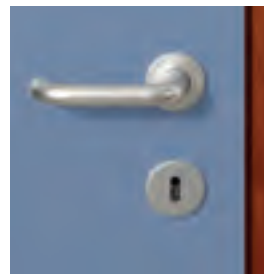

PREMI APRI
/ PUSH-OPEN



PREMI APRI FORMA
/ PUSH-OPEN FORM



LIBERO OCCUPATO solo per versione anta in laminato sp.14 mm
/ FREE-BUSY RESIN / only for 14 mm thick laminate door version

interno / inside



esterno / outside



Maniglie solo per scorrevoli / Handles only for sliding



finiture disponibili / available finishes:

- ottone** / brass
- cromo satinato** / satin chrome
- cromo lucido** / polished chrome
- nero** / black
- bianco** / white

Maniglioni / Pull handles

MANIGLIONE ANTIPANICO
/ PANIC HANDLE

interno / inside



MANIGLIONE PUSHBAR
/ PUSHBAR HANDLE

interno / inside

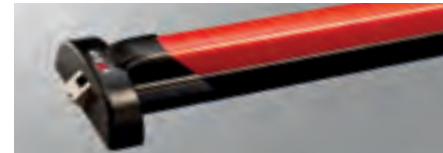

Chiudiporta / Closers

CHIUDIPORTA AEREO
/ AERIAL CLOSER



Griglie / Grids

ALLUMINIO / ALUMINIUM



misure disponibili / available size:

- 40x20 cm
- 30x20 cm

MANIGLIA NERA CON CILINDRO
/ BLACK HANDLE WITH CYLINDER

esterno / outside



MANIGLIONE FISSO PER DISABILI
/ HANDLES FOR HANDICAPPED



Protezioni / Precautions

FASCE BATTICARRELLO
/ DEFLECTOR BANDS



ABS



misure disponibili / available size:

- 33,5x9 cm
- 33,5x19 cm

finiture disponibili / available finishes:

- nero** / black
- bianco** / white

Graphic Project:
Combos

Flessya srl
via dell'Artigianato 13
60030 Monte Roberto AN
tel 0731.70.74.11
fax 0731.70.74.70
info@flessya.it
www.flessya.com



mille modi per dire porta

